



Useful Information About Your Home

The information provided herein is for you, the homeowner, to be able to source replacement materials so you can maintain your home in excellent repair.

P.1 Door Closer

P.2 Front Door Lock

P.3 Smoke Alarm

P.4 Bathroom Exhaust Fan

P.5 Window Warranty

P.6 Bathroom Hardware

Available at ACE Hardware 772-461-5950
 Color: White

Model: DC7
 SIZE 3

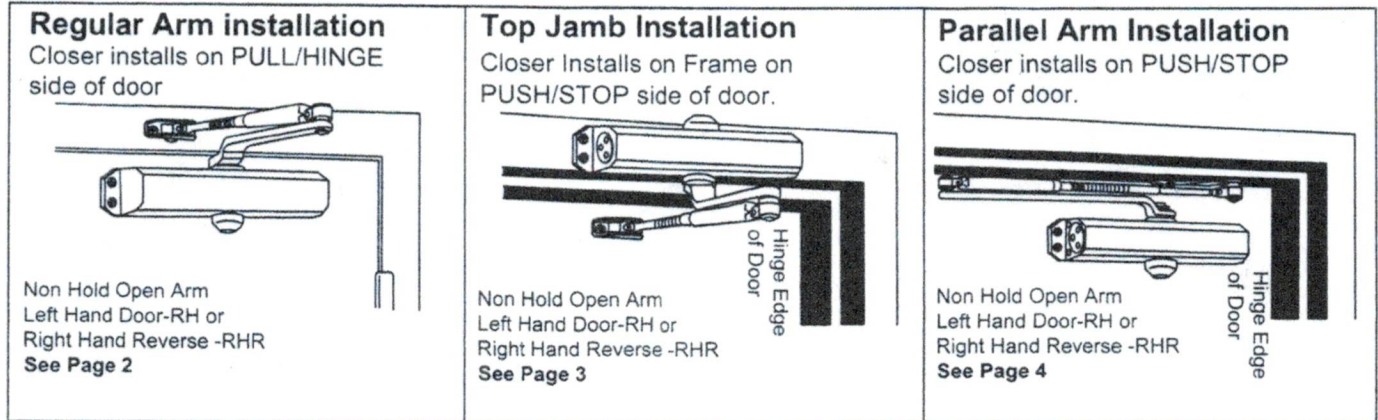

DOOR CLOSER ADJUSTMENT

CLOSING CYCLE

NOTE: CLOSING arcs (CLOSE and LATCH) are controlled two (2) separate speed adjusting valves. adjust the CLOSING speed first, then adjust the LATCHING speed.

- CLOSING speed adjustment is accomplished by full rotations of the speed adjusting valve.
 - Turn the speed adjustment valve CLOCKWISE for a SLOWER CLOSE arc closing speed.
 - Turn the speed adjustment valve COUNTER-CLOCKWISE for a FASTER CLOSER arc closing speed.
- LATCH speed adjustments is accomplished by full rotations of the speed adjusting valve.
 - Turn the speed adjustment screw CLOCKWISE for a SLOWER LATCH arc closing speed.
 - Turn the speed adjustment screw COUNTER-CLOCKWISE for a FASTER LATCH arc closing speed.

CAUTIONS!

Do not turn speed adjusting valve more than two (2) full turns counter-clockwise from its factory set position, as two speed adjusting valves could become dislodged from the door closer body, resulting in the loss of internal fluid and failure of the device.

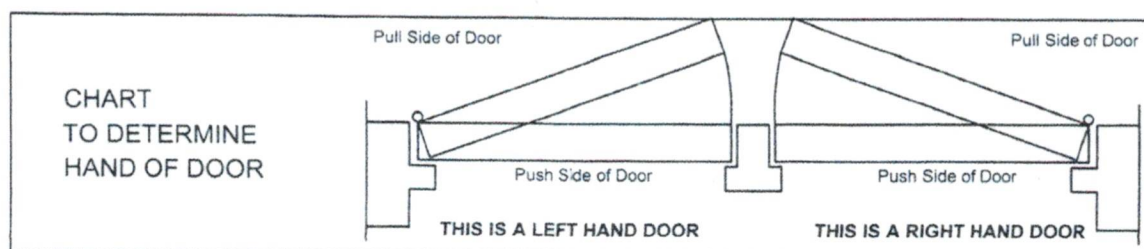
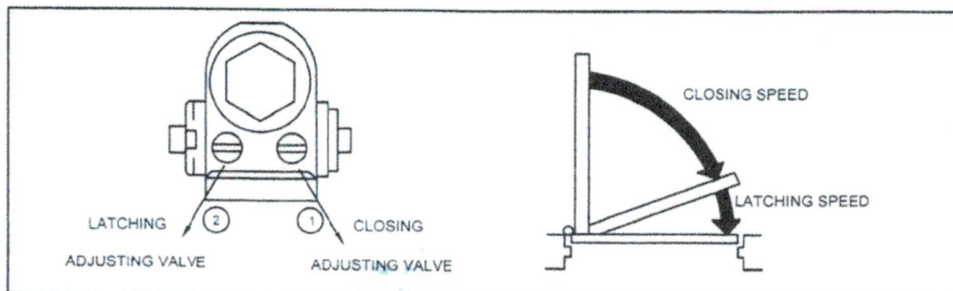



DID YOU KNOW?

Tarnished hardware on your front door has a lifetime warranty if you are the **original owner** and may be replaced directly through the manufacturer!

Call Schlage at 1-800-847-1864

- Schlage – F10 Accent 625 Passage (**Shiny Chrome**)
- Schlage deadbolt B360-single cylinder (**Shiny Chrome**)

If you want your deadbolt to use the same key you must call the office for the original 5 digit code.

For second owners replacement hardware is available from precision Door Hardware Co. Inc. by calling 1-888-306-2298

Ionization Smoke & Fire Alarm

120 Volt AC Hardwired with Battery Backup

Model 5304



Perfect for new or replacement installations, this 120 volt AC/DC hardwired smoke and fire alarm

Features

- Quick Find® alarm origination feature
- Quick activation battery pull tab
- Universal mounting bracket
- Quick connect wiring harness
- Larger mounting base
- Interconnectable
- Front-load battery drawer
- Single silence/test button
- Full-size plastic dust cover
- 2 tamper resistant locking features
- 10-year alarm warranty

Benefits

- Patented feature easily identifies first alarm to sound in an interconnected system
- Preserve battery life. Preinstalled battery is quickly activated without removing alarm from bracket
- Fits any standard wiring junction box, single gang, round or octagon, up to 4"
- Longer 8" pigtail wires are pre-stripped
- Covers drywall imperfections and old paint marks
- With all USI and Universal brand 120V alarm using existing wiring & mounting
- Replace battery without removing alarm from bracket
- Temporarily quiets nonemergency alarms and tests alarm functionality
- Protects alarm from dust, debris and painting during construction or home remodeling
- Prevents unauthorized alarm and battery removal
- 10 years from the date of installation

Technical Specifications

Sensor Type:	Dual Ionization Sensing Chamber
Primary Power:	120 Volt AC 60Hz
Battery Backup:	9 Volt super heavy duty battery
Audible Alarm:	85 dB at 10 feet
Temperature Range:	40° F to 100° F (4° C to 38° C)
Humidity Range:	5% to 95% RH
Interconnect:	Maximum 24 USI/Universal devices
LED:	Green=AC power, Red=alarm
Size:	5.63" x 5.63" x 1.75"
Warranty:	10 year limited

Regulatory Compliance:

- Underwriters Laboratories (UL-US)
- Underwriters Laboratories Canada (ULC)
- California State Fire Marshal (CSFM)
- National Fire Protection Association (NFPA)
- Housing and Urban Development (HUD)
- Federal Housing Authority (FHA)
- UTGT / UTHA



MODEL	BRAND	Box		SHELF PACK (in.)		WEIGHT (Lbs.)	UPC CODE	QTY	MASTER CTN (in.)		WEIGHT (Lbs.)	I2 of 5
		Clam	QTY	L x W x H	L x W x H							
5304	USI	BX	1	5.75 x 5.75 x 1.75	0.42	0-42741-05304-4	12	12.00 x 12.00 x 6.13	8.55	1-00-42741-05304-1		

UNIVERSAL
SECURITY INSTRUMENTS, INC.
ALWAYS WORKING TO
PROTECT YOUR FAMILY®

Corporate Office
11407 Cronhill Dr., Suite A, Owings Mills, MD 21117
Phone: 800.390.4321
Fax: 410.363.2218
Web: www.UniversalSecurity.com www.UsiElectric.com



© 2010 Universal Security Instruments, Inc.
Rev. 05012019
CM107A



SPECIFICATIONS

SUPREME Series Ventilation Fan

MODEL#: PA700VLE

DESCRIPTION - Very quiet ventilation fans with compact fluorescent lighting with performance as noted in the table below.
California: TITLE 24 READY

BODY - This is made from painted heavy gauge sheet metal for protection against rusting.

MOTOR - 4 pole plug in motor, life time lubrication, rated for continuous use. 120V/60Hz.

FAN HOUSING

- * Painted galvanized steel housing.
- * Housing Dimensions: 9 1/16" x 9 1/16" x 7 3/4"

GRILLE & LIGHTING

- * White polymeric grille with plastic lens complete with torsion clips for secure hold.
- * Requires 2 x 13 watt G24q-2 Base Lamps (not included).
- * Grille Dimensions: 12 1/2" x 12 1/2"

DUCT COLLAR

- * Select either 4" or 5" duct collar, weighted noiseless backdraft damper.
- * Painted galvanized steel.

MOUNTING

- * Rated for installation in ceilings up to R40.
- * Double hanger bar system for ideal positioning.
- * Expandable extension bracket up to 24".
- * Drywall Rough in opening is 9" x 9".
- * Acceptable for use over tub or shower when installed with a GFCI protected circuit.

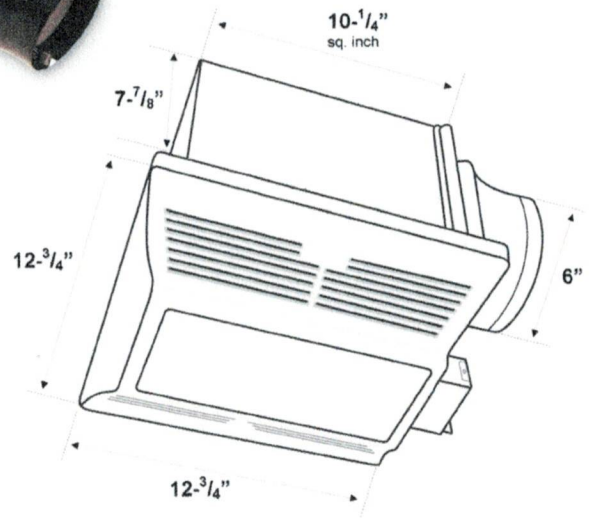
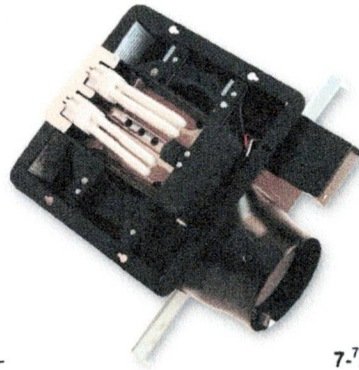

AIR PERFORMANCE (CFM)

Model	Static pressure (inches of wg)										Air flow (cfm)	Sones @ 0.1	Current (amp)	Power (watt)	RPM (nominal)	Electrical rating	Room size Capacity
	0	0.1"	0.15"	0.2"	0.25"	0.3"	0.35"	0.4"	0.45"	0.5"							
PA700VLE*	90	77	70	62	53	44	24	6			70	0.4	0.159	20	1050	120V/60Hz	60 - 80

Bathroom Exhaust fan –

N.B. replacement does not include light or cover grill.

Contact Jay Shadi at 323-588-3600

Model # BPT14-13AL PA700VLE

Cost \$55.00 plus approx. \$10.00 shipping



5681 South Downey Road, Vernon CA 90058 USA
1-866 588-1124 toll free 323 588-3600/323 588-0141 fax

www.airzonefans.com

Certifications:



PGT® Windows & Doors

Warranty

PGT Industries, Inc. ("PGT"), warrants to the original owner that any PGT manufactured window or door shall be free of material defects in manufacturing and/or materials for the period specified below. This warranty applies to the window/door under normal use and service, subject to the conditions and limitations herein listed, and for only so long as the original owner owns the windows and doors. PGT's liability under this warranty shall be limited to the repair or replacement of nonconforming goods or parts, at PGT's option. PGT shall not be responsible for any incidental or consequential damages that may arise out of a claim for breach of this warranty.

This warranty covers only those manufacturing and material defects as specified herein and does not include defects or damages attributable to improper installation and/or application of product, use or maintenance; normal weathering; highly corrosive environments; defects caused by accident, fire, flood, acts of God, vandalism, riot or civil disorder; building settlement or structural failures of walls or foundations; stresses resulting from localized heat which causes excessive temperature differentials over glass surface edges, or occurrences beyond PGT's control.

This warranty shall be null and void if harmful solvents are used to clean the frame and/or sash members, or if the frame and/or sash members are painted or coated in anyway; or if any other "aftermarket" products are applied to the PGT product such as window films.

PGT's sole responsibility under this warranty is limited to repairing or replacing (color may vary due to age, weathering or die lot differences), free of charge or at a prorated price per guidelines of this instrument, any part or parts of the windows that do not comply with the terms of this warranty. The original warranty period shall not be extended by such repair or replacement.

PGT reserves the right to discontinue or change the design and specification of any product it manufactures. Should the component of the window/door originally installed not be available, PGT shall have the right to substitute such part determined by PGT to be of equal quality and performance.

Aluminum Frame

The aluminum components of the frame/sash members are warranted to be free of defects in materials and workmanship for a period of three (3) years after the date of delivery by PGT. Warranty is null and void if any aluminum component has direct contact with a copper treated wood, such as Alkaline Copper Quaternary (ACQ).

Vinyl Frame

The vinyl components of the frame/sash members are warranted against defects resulting from blistering, chipping, cracking, peeling, corroding or pitting for a period of ten (10) years after the date of delivery by PGT. Should the vinyl fail after year 10 as a result of defects described above, PGT will charge the purchaser, and the purchaser shall pay PGT a fixed price for the replacement frame/sash at that time, according to the formula below.

Years 11 through 15	- 50% of the then-current price for the frame/sash
Years 16 through 20	- 70% of the then-current price for the frame/sash
Years 21 through 25	- 80% of the then-current price for the frame/sash
Years 26 on	- 90% of the then-current price for the frame/sash

Glass

Glass has prevalent characteristics such as bubbles, slight discolorations, blurs, and hairline scratches. These are expected, as they are inherent qualities that meet or exceed federal specifications DD-G-451D. Heat strengthened or tempered glass may have slight distortions as an inherent quality. Glass with special coatings may require special cleaning, please see your PGT dealer.

PGT warrants against stress cracks in glass panels for a period of 12 months after the date of delivery by PGT. Stress cracks in glass panels can result from natural settlement or extreme thermal changes between inside and outside temperatures. Stress cracks are not the result of defects in materials and/or workmanship. In the event of a stress crack during the 12-month warranty period, PGT will ship a replacement panel to the original owner at no cost (installation costs are not covered).

Insulating Glass Unit

The sealed glass component is warranted to be free of defects resulting in material obstruction of vision or film formation caused by dust or moisture in the dead air space of a sealed unit for a period of ten (10) years after the date of delivery by PGT. Should the glass fail after year ten as a result of defects described above, PGT will charge original owner, and the original owner shall pay PGT, a fixed price for glass at that time, according to the formula below. In the event of glass failure, PGT will ship a replacement panel to the original homeowner at no cost (installation costs are not covered).

Years 11 through 15	- 50% of the then-current price for the glass
Years 16 through 20	- 70% of the then-current price for the glass
Years 21 through 25	- 80% of the then-current price for the glass
Years 26 on	- 90% of the then-current price for the glass

Laminated Glass Unit

The glass is warranted to be free of defects resulting in material obstruction of vision or delamination for a period of five (5) years from the date of delivery by PGT.

Screen and Moving Parts

The screen and moving parts shall be warranted for a period of three (3) years after the date of delivery by PGT to be free from material defects in manufacturing and/or materials.

Claims

Any claim for defect under this warranty must be submitted promptly after discovery to the dealer from whom the product was purchased and within the warranty period specified above. If you cannot locate your PGT dealer, you may contact PGT for assistance.

PGT
Attn: Service Department
P.O. Box 1529
Nokomis, FL 34274

PGT products are tested and manufactured to current fenestration standards.

Some states do not allow the exclusion or limitation of incidental consequential damages or the limitation of remedies for a breach of warranty, so the above limitations or exclusions may not apply to you. This warranty gives you specific legal rights, and you may also have other rights that vary from state to state. No distributor, dealer or representative of PGT has the authority to change or modify this warranty in any respect, either orally or in writing.

EXCEPT AS EXPRESSLY PROVIDED IN THIS WARRANTY, PGT MAKES NO WARRANTY, EXPRESS OR IMPLIED, INCLUDING NO WARRANTY OF MERCHANTABILITY, NO WARRANTY OF FITNESS FOR PARTICULAR PURPOSE AND NO WARRANTY OF NONINFRINGEMENT.

Home → Products → Bath Accessories → Aspen

Aspen chrome 18" towel bar

★★★★★ 4.7 (7) [Write a review](#)



Chrome [5818CH]

\$12.15
MSRP ⓘ

Aspen chrome 24" towel bar

★★★★★ 4.7 (3) [Write a review](#)



Chrome [BP5824CH]

\$12.90
MSRP ⓘ



Open until 9PM!
ST. Lucie West Lowe's ▾



Aspen chrome spring loaded paper holder

★★★★★ (0) [Write a review](#)



Chrome [BP5808CH]

\$10.35
MSRP ⓘ

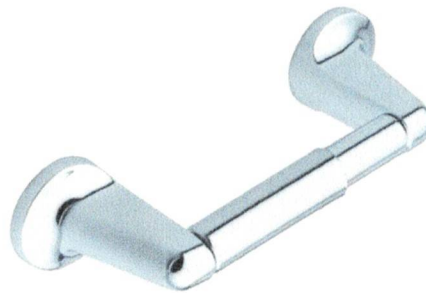

Home → Products → Bath Accessories → Aspen

Aspen chrome single robe hook

★★★★★ 4.7 (3) [Write a review](#)



Chrome [5802CH]

\$4.25
MSRP ⓘ

Aspen chrome towel ring

★★★★★ (0) [Write a review](#)



Chrome [BP5886CH]

\$8.15
MSRP ⓘ

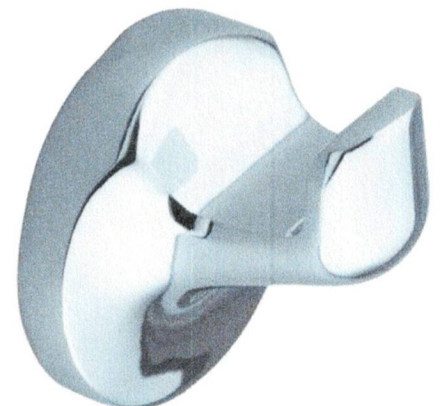

All these Moen products that match the original builder's bathroom fixtures are available at the St. Lucie Lowe's